

TRENT 2 AL5000



Asymmetric



Double Asymmetric



Symmetric



Street Lighting

Benefits

- Luminaire body is treated to guarantee high corrosion resistance, thus lengthening the life span of the lantern body
- Aesthetic styling suitable for architectural and commercial locations
- 50° high grade performance reflector available to give highly efficient light output

Technical Features

- IP66 and IK08 rated
- Class I as standard, Class II available on select ranges upon request
- Three beam types available: Asymmetric, Double Asymmetric, Symmetric
- Options for beam widths available for each beam type
- Die cast aluminium body and front frame, degreased and phosphor chromate treated with surface protection coat and polyester powder coating
- Double goniometric scale for ease of vertical aiming on site
- Anti-aging silicon rubber gasket
- Tempered glass with high temperature thermal shock, mechanically fixed into the frame

- Pressure compensation filter on the body
- Stirrup mounting or 60mm diameter post mount
- Access options: Hexagon stainless steel screws, or tool-less access by stainless steel securing clip. State on order

- Multiple light source options available (LED)

Applications

- Area
- Sport

Colour

- Light Grey

Dimensions

Dimensions in mm

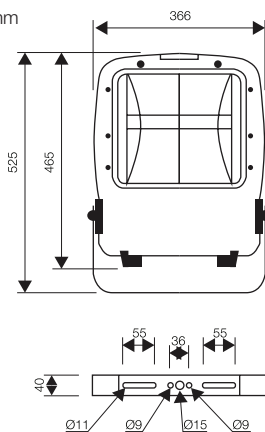

Body Type 4

AL5047, AL5042, AL5045, AL5043, AL5046, AL5086/P, AL5080/S

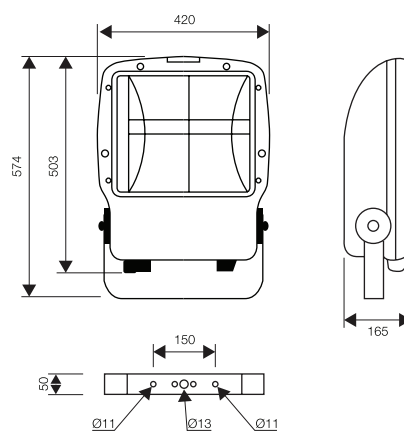

Body Type 5

AL5057, AL5052, AL5055, AL5058, AL5053, AL5066/P, AL5090/S



Key features

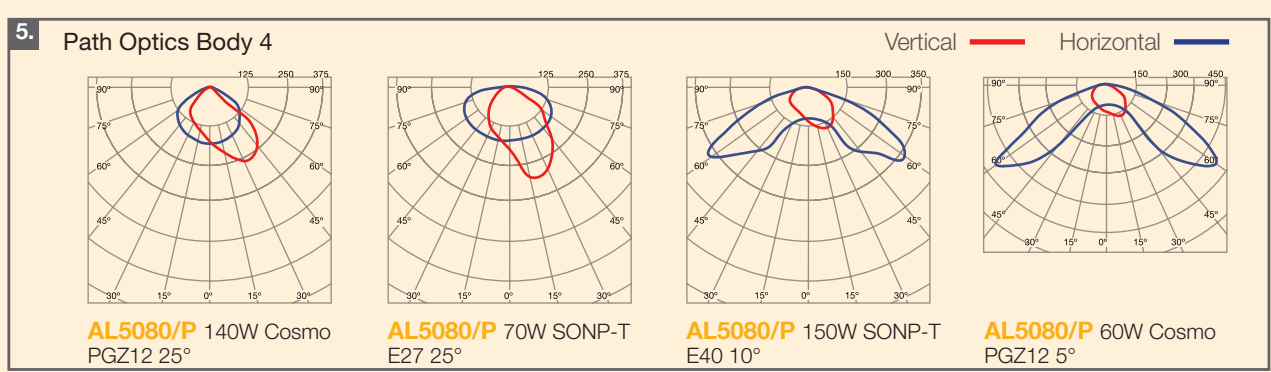
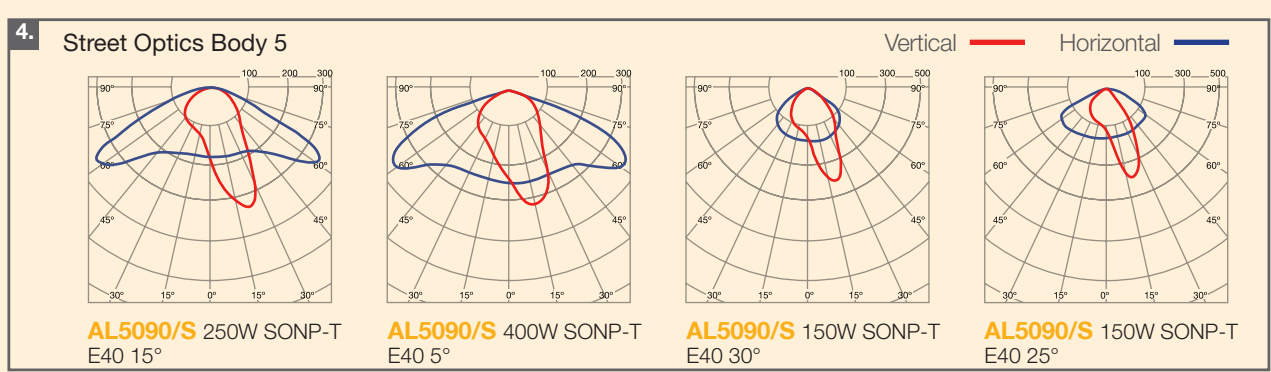
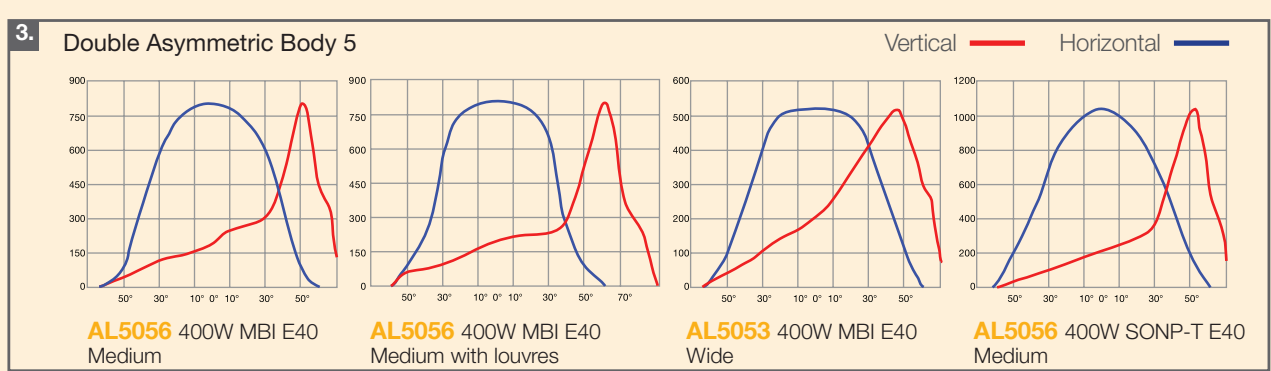
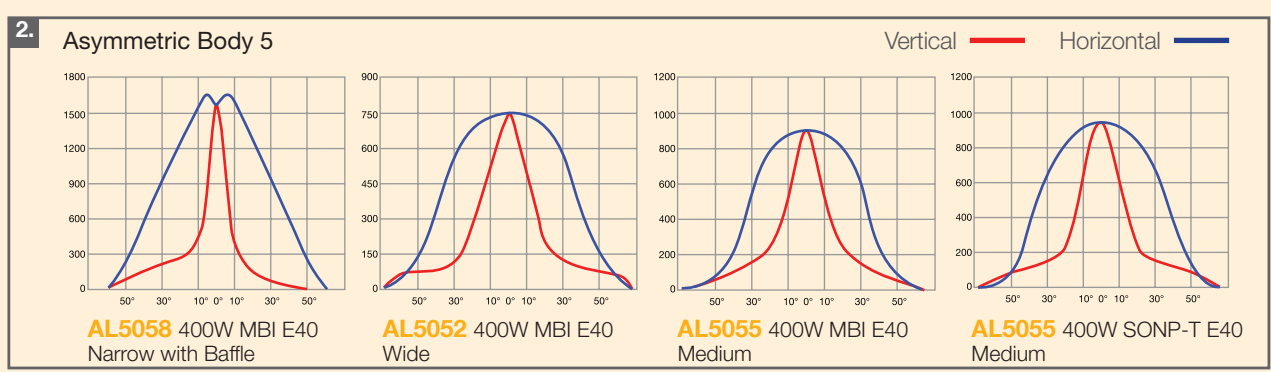
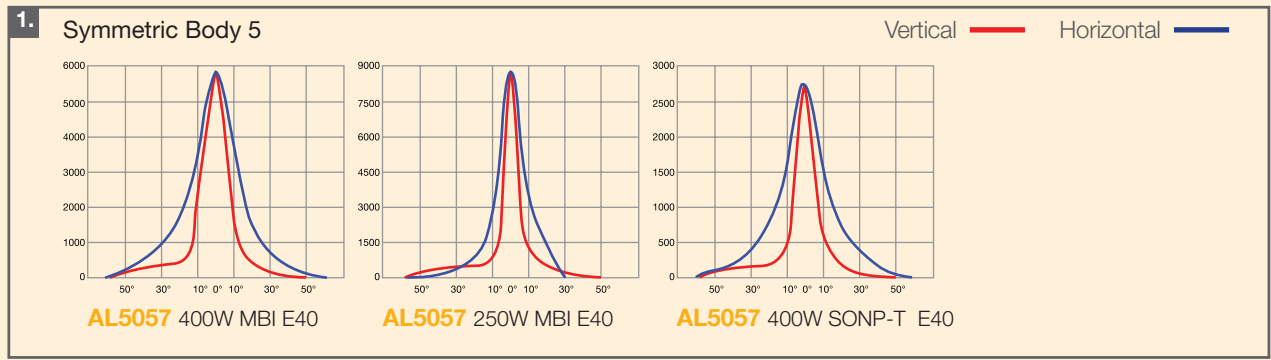

Technical Specifications

	Lamp Wattage	Light Source	Lamp Holder	Conventional Ballast	Electronic Ballast Available (E)	Body Type	Light Distribution Type	Weight (kg)	Wind Area (m2)	Mount
AL5047	100W	MBI, SONP-T	E40	Y	Y	4		8.71kg	0.14	Stirrup or wall mount
	150W	MBI, SONP-T	E40	Y	Y	4	Symmetric	9.58kg	0.14	
	250W	MBI, SONP-T	E40	Y	N	4	Narrow	10.76kg	0.14	
	210W	CDM-T	PGZ18	N	Y	4		8.70kg	0.14	
AL5042	100W	MBI, SONP-T	E40	Y	Y	4		8.71kg	0.14	Stirrup or wall mount
	150W	MBI, SONP-T	E40	Y	Y	4	Asymmetric	9.58kg	0.14	
	250W	MBI, SONP-T	E40	Y	N	4	Wide	10.76kg	0.14	
	210W	CDM-T	PGZ18	N	Y	4		8.70kg	0.14	
AL5045	100W	MBI, SONP-T	E40	Y	Y	4		8.71kg	0.14	Stirrup or wall mount
	150W	MBI, SONP-T	E40	Y	Y	4	Asymmetric	9.58kg	0.14	
	250W	MBI, SONP-T	E40	Y	N	4	Medium	10.76kg	0.14	
	210W	CDM-T	PGZ18	N	Y	4		8.70kg	0.14	
AL5043	100W	MBI, SONP-T	E40	Y	Y	4	Double	8.71kg	0.12	Stirrup or wall mount
	150W	MBI, SONP-T	E40	Y	Y	4	Asymmetric	9.58kg	0.12	
	250W	MBI, SONP-T	E40	Y	N	4	Wide	10.76kg	0.12	
	210W	CDM-T	PGZ18	N	Y	4		8.70kg	0.12	
AL5046	100W	MBI, SONP-T	E40	Y	Y	4	Double	8.71kg	0.12	Stirrup or wall mount
	150W	MBI, SONP-T	E40	Y	Y	4	Asymmetric	9.58kg	0.12	
	250W	MBI, SONP-T	E40	Y	N	4	Medium	10.76kg	0.12	
	210W	CDM-T	PGZ18	N	Y	4		8.70kg	0.12	
AL5057	150W	MBI, SONP-T	E40	Y	N	5		12.05kg	0.17	Stirrup or wall mount
	250W	MBI, SONP-T	E40	Y	N	5	Symmetric	13.35kg	0.17	
	400W	MBI, SONP-T	E40	Y	N	5	Narrow	14.55kg	0.17	
	315W	CDM-T	PGZ18	N	Y	5		12kg	0.17	
AL5052	150W	MBI, SONP-T	E40	Y	N	5		12.05kg	0.17	Stirrup or wall mount
	250W	MBI, SONP-T	E40	Y	N	5	Asymmetric	13.35kg	0.17	
	400W	MBI, SONP-T	E40	Y	N	5	Wide	14.55kg	0.17	
	600W	SONP-T	E40	Y	N	5		16.50kg	0.17	
	315W	CDM-T	PGZ18	N	Y	5		12kg	0.17	
AL5055	150W	MBI, SONP-T	E40	Y	N	5		12.05kg	0.17	Stirrup or wall mount
	250W	MBI, SONP-T	E40	Y	N	5	Asymmetric	13.35kg	0.17	
	400W	MBI, SONP-T	E40	Y	N	5	Medium	14.55kg	0.17	
	315W	CDM-T	PGZ18	N	Y	5		12kg	0.17	
	150W	MBI, SONP-T	E40	Y	N	5		12.05kg	0.17	
AL5058	250W	MBI, SONP-T	E40	Y	N	5	Asymmetric	13.35kg	0.17	Stirrup or wall mount
	400W	MBI, SONP-T	E40	Y	N	5	Narrow	14.55kg	0.17	
	600W	SONP-T	E40	Y	N	5		16.50kg	0.17	
	315W	CDM-T	PGZ18	N	Y	5		12kg	0.17	
	150W	MBI, SONP-T	E40	Y	N	5		12.05kg	0.13	
AL5053	250W	MBI, SONP-T	E40	Y	N	5	Double	13.35kg	0.13	Stirrup or wall mount
	400W	MBI, SONP-T	E40	Y	N	5	Asymmetric	14.55kg	0.13	
	600W	SONP-T	E40	Y	N	5	Wide	16.50kg	0.13	
	315W	CDM-T	PGZ18	N	Y	5		12kg	0.13	
	150W	MBI, SONP-T	E40	Y	N	5		12.05kg	0.13	
AL5056	250W	MBI, SONP-T	E40	Y	N	5	Double	13.35kg	0.13	Stirrup or wall mount
	400W	MBI, SONP-T	E40	Y	N	5	Asymmetric	14.55kg	0.13	
	600W	SONP-T	E40	Y	N	5	Medium	16.50kg	0.13	
	315W	CDM-T	PGZ18	N	Y	5		12kg	0.13	
	50W,70W,100W,150W	MBI, SONP-T	E27-E40	Y	N	4		9.2 - 10.45kg	0.083	
AL5080/S	45W,60W,90W,140W	CPO-TW	PGZ12	N	Y	4	Street Optic	9.55kg	0.083	Stirrup or wall mount
	150W	CDM-T	G12	N	Y	4		10.45kg	0.083	
AL5080/P	50W,70W	SONP-T	E27	Y	N	4	Cycle Path	9.2kg	0.083	Stirrup or wall mount
	45W,60W	CPO-TW	PGZ12	N	Y	4	Optic	9.55kg	0.083	
AL5090/S	250W,400W	MBI, SONP-T	E40	Y	N	5	Street Optic	13.15kg	0.112	Stirrup or wall mount
	315W	CDM-T	PGZ18	N	Y	5		11kg	0.112	